

**Introduction to the MICTOR Interconnection System
(0.64 [.025] Centerline)**

Product Facts

- 76 dedicated signal lines per linear inch
- Surface mount family designed for parallel and right angle board-to-board, flex-to-board and cable-to-board configurations
- 0.64 [.025] centerline contact spacing
- Redundant interfaces on mated contacts
- Fifteen mated stack heights available ranging from 6.60 [.260] to 31.90 [1.256]
- Infrared and forced air convection compatible housing materials
- Designed for 50-ohm systems
- Connector housings polarized for correct mating
- Built-in connector-to-board retention feature
- Connector can be separated by peeling from one end to the other
- Various packaging styles can be made available for automated assembly (tape and reel, tubes)
- Recognized under the Component Program of Underwriter Laboratories Inc.  File No. E28476



The MICTOR connector family is based on the microstrip concept of two rows of signal contacts divided by a center power ground plane. MICTOR connectors are mother-board and daughtercard compatible and include designs for cable-to-board applications.

Various mated heights are available for parallel board-to-board systems. Custom stacking heights can be

provided. The MICTOR connector family is available in 0.64 [.025] centerlines and in sizes ranging from 38 signal positions to 266 positions (in increments of 38 positions). There is a discrete ground bus every 12.7 [.50] of the connector length, which can be assigned to either power or ground in any combination.

Redundant interfaces on every signal line provide added reliability. Two plating

options are available to meet the needs of various applications.

The housing material is a liquid crystal polymer, compatible with infrared and forced air convection operations.

The connector system uses the solid ground bus between the rows of signals to provide low crosstalk and excellent high-speed signal characteristics.

0.635mm MICTOR Connectors

MICTOR Connector Cross Section

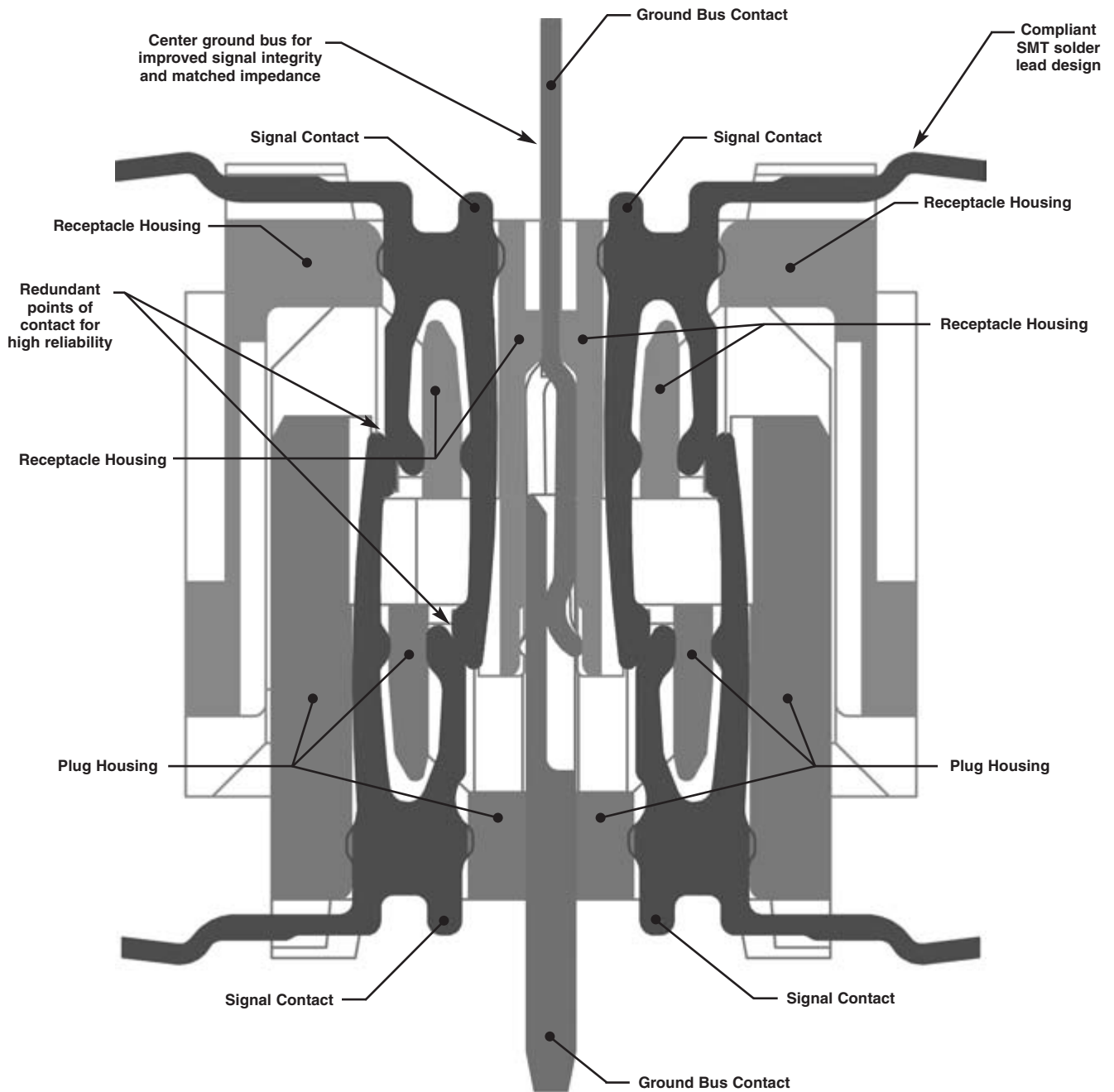

Connectors are shown at point where signal contact first touch each other.
Connectors are designed to be fully mated when the two "Z" datums meet.

0.635mm MICTOR Connectors

Material and Performance Specifications, MICTOR Connectors

Material Specifications

Material

Housing — Liquid crystal polymer, black

Contacts — High reliability copper alloy

Ground Bus — Phosphor bronze

Finish (Gold Plating)

Contacts and Ground Bus — 0.00076 [.000030] min. gold on contact area, 0.00381-0.00635 [.000150-.000250] matte tin per ASTM B 545 on leads, all over 0.00177-0.00445 [.000070-.000175] nickel.

Finish (Palladium-Nickel Plating)

Contacts and Ground Bus — 0.00013 [.000005] min. gold over, 0.00076 [.000030] min. palladium nickel on contact area, 0.00381-0.00635 [.000150-.000250] matte tin per ASTM B 545 on leads, all over 0.00191-0.00445 [.000075-.000175] nickel.

Performance Specifications

Ratings

Voltage — 30 vac

Current — Signal; rated 1.0 Amps, fully derated 0.5 Amps
Ground; rated 11.5 Amps, fully derated 7.6 Amps

Temperature — -55°C to +125°C

Electrical Characteristics

Characteristic Impedance — 50±5 ohms at 1 ns

Termination Resistance — ΔR 10 milliohms max.; AMP Specification 109-6-1

Insulation Resistance — 10,000 megohms min.; AMP Specification 109-208-1

Dielectric Withstanding Voltage — 500 vac at sea level; AMP Specification 109-29-1

Mechanical Characteristics

Solderability — Solderable area shall have a 95% min. solder coverage; AMP Specification 109-11-1

Vibration (Random) — No discontinuities of 1μs or longer duration; AMP Specification 109-21-5

Physical Shock — No discontinuities of 1μs or longer duration; AMP Specification 109-26-1

Durability (Tested to) — Mate and unmate samples at a rate of 600 cycles max. per hour. 25 cycles, gold plating; 500 cycles, palladium-nickel plating; AMP Specification 109-27

Contact Retention — 1 lb min.; AMP Specification 109-30

Mating Force — 152 oz max. per 1/2 inch of connector (1 module). Each module equals 38 signal contacts and 1 ground bus; AMP Specification 109-42

Unmating Force — 19 oz min. per 1/2 inch of connector (1 module). Each module equals 38 signal contacts and 1 ground bus; AMP Specification 109-42

Environmental Characteristics

Thermal Shock — Subject mated samples to 5 cycles between -55°C and +125°C; AMP Specification 109-22

Humidity - Temperature Cycling — Subject mated samples to 10 cycles between +25°C and +65°C at 95% RH; AMP Specification 109-23-3, Condition B

Temperature Cycling — Subject mated samples to 1024 cycles between -40°C and +60°C at 2 hours per cycle; AMP Specification 109-75-1

Temperature Life — Subject mated samples to temperature life at +118°C for 792 hours; AMP Specification 109-43

Mixed Flowing Gas — Subject mated samples to environmental class II for 14 days; AMP Specification 109-85-2

MICTOR Stack Height Combinations

**30µ Gold and Palladium
Nickel Plated Vertical
Connectors**

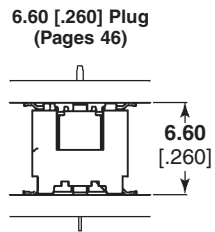

6.60 [.260] Plug
(Pages 46)
Standard Receptacle
(Pages 56 and 57)

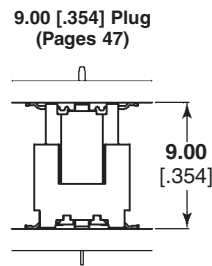

9.00 [.354] Plug
(Pages 47)
Standard Receptacle
(Pages 56 and 57)

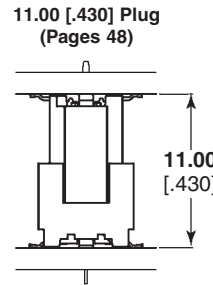

11.00 [.430] Plug
(Pages 48)
Standard Receptacle
(Pages 56 and 57)

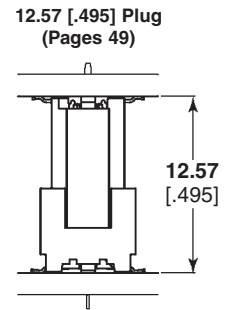

12.57 [.495] Plug
(Pages 49)
Standard Receptacle
(Pages 56 and 57)

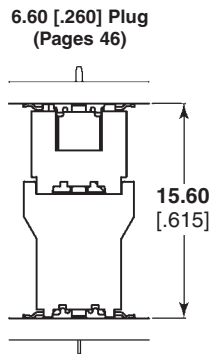

6.60 [.260] Plug
(Pages 46)
Raised Receptacle
(Pages 58 and 59)

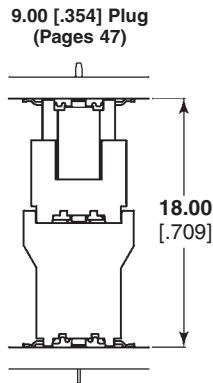

9.00 [.354] Plug
(Pages 47)
Raised Receptacle
(Pages 58 and 59)

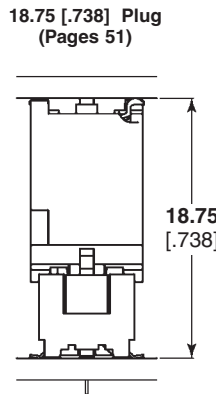

18.75 [.738] Plug
(Pages 51)
Standard Receptacle
(Pages 56 and 57)

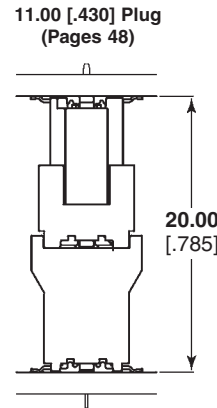

11.00 [.430] Plug
(Pages 48)
Raised Receptacle
(Pages 58 and 59)

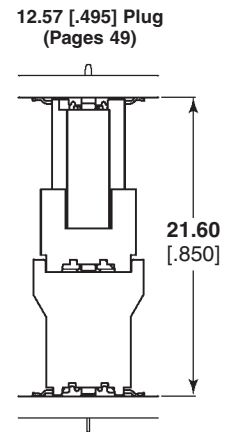

12.57 [.495] Plug
(Pages 49)
Raised Receptacle
(Pages 58 and 59)

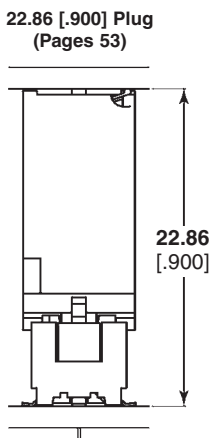

22.86 [.900] Plug
(Pages 53)
Standard Receptacle
(Pages 56 and 57)

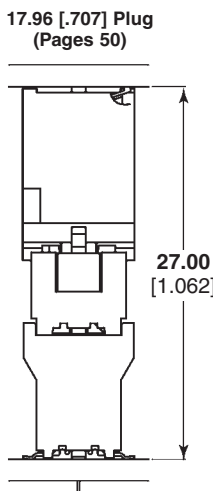

17.96 [.707] Plug
(Pages 50)
Raised Receptacle
(Pages 58 and 59)

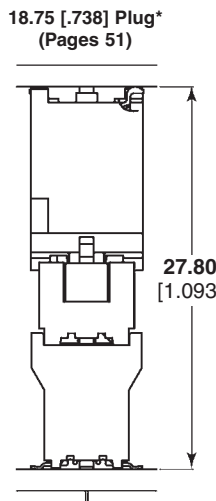

18.75 [.738] Plug*
(Pages 51)
Raised Receptacle
(Pages 58 and 59)

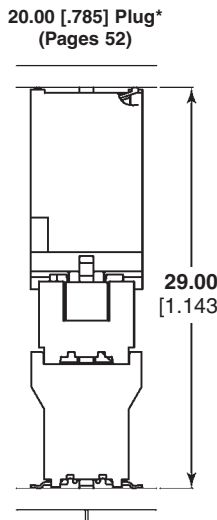

20.00 [.785] Plug*
(Pages 52)
Raised Receptacle
(Pages 58 and 59)

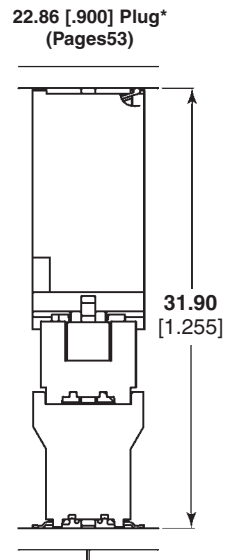

22.86 [.900] Plug*
(Pages 53)
Raised Receptacle
(Pages 58 and 59)

*This connector not available in Palladium Nickel.

0.635mm MICTOR Connectors

30µ Gold & Palladium
Nickel Connections

MICTOR Right Angle (Straddle Mount) Combinations

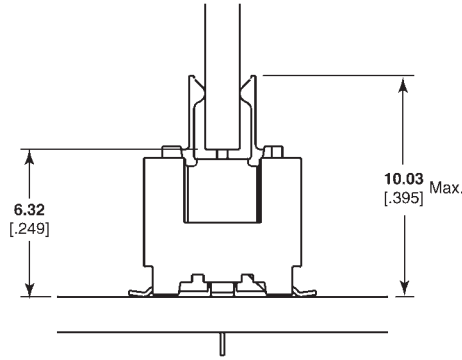

Vertical Receptacle with
Right Angle Plug

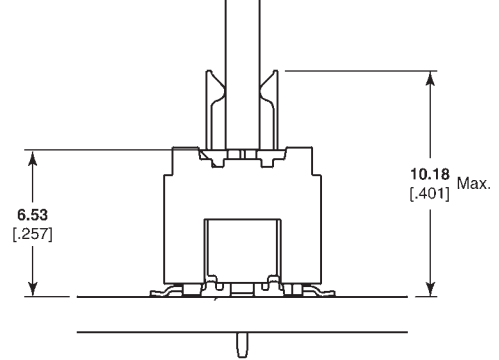

Vertical Plug with
Right Angle Receptacle

Right angle versions are designed for paddlecard type applications. It is highly recommended that customers who are considering right angle applications contact Tyco Electronics

Engineering to review their applications as the potential for tolerancing issues and/or issues of solder joint integrity can be highly application specific.

0.635mm MICTOR Connectors

MICTOR Vertical Plugs

**6.60 [.260]
Stacking Height***

Related Product Data

- Material and Finish** — page 43
- Performance Characteristics** — page 43
- Mating Receptacles** — pages 56-61
- Technical Documents** — page 113

*6.60 [.260] stack height when mated to vertical receptacle; 15.62 [.615] stack height when mated to vertical receptacle (extended height).

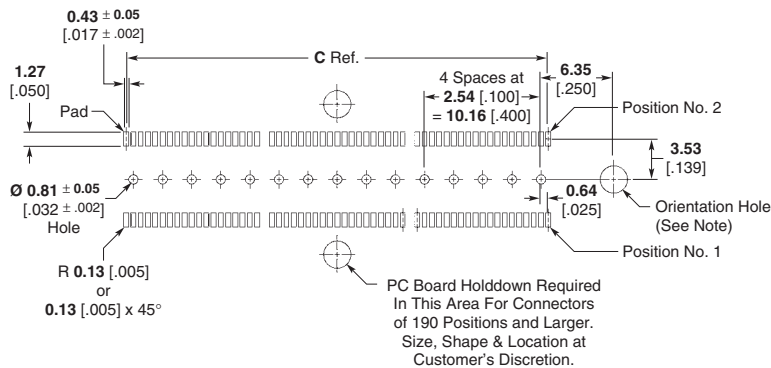
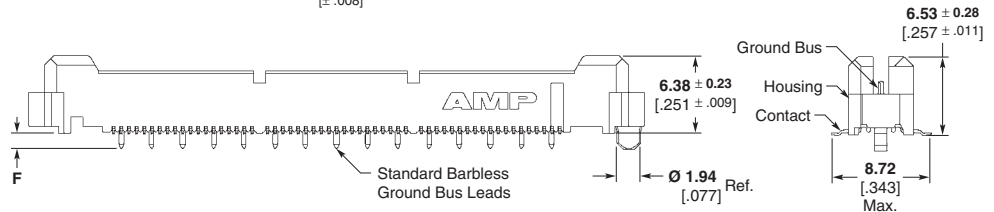
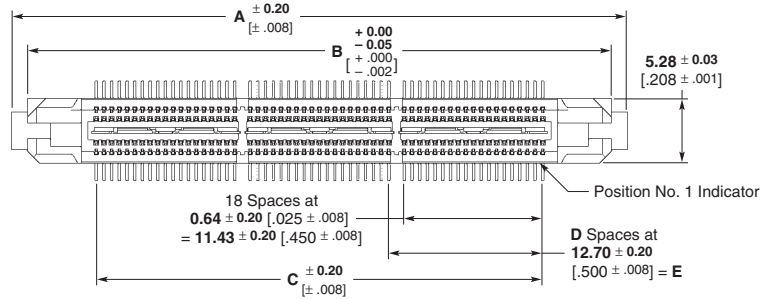

Note: For standard applications, the orientation hole must be 2.39±0.05 [.094±.002]; For slip-fit applications, the orientation hole must be 2.00±0.03 [.079±.001].

**Recommended PC Board Layout
(Viewed from Connector Side)**

No. of Pos.	Dimensions						Part Numbers							
							Platings		Barbed G/B Leads			Barbless G/B Leads		
	A	B	C	D	E	F	Solder Tail	Contact	Tube	T&R Vacuum Caps		Tube	T&R Vacuum Caps	
										With	Without		With	Without
38	25.40 1.000	22.81 .898	11.43 .450	0	—	1.35 [.053] 2.72 [.107] 2.64 [.104]	Sn	Gold	5767007-8	5767111-8	5767111-1	5767116-1	5767118-1	5767118-8
									PdNi	5767056-1	—	—	—	—
									—	—	—	5767117-1	5767119-1	5767119-8
76	38.10 1.500	31.70 1.248	24.13 .950	1	12.70 .500	1.35 [.053] 2.72 [.107] 2.64 [.104]	Sn	Gold	5767007-9	5767111-9	5767111-2	5767116-2	5767118-2	5767118-9
									PdNi	5767056-2	—	—	—	—
									—	—	—	5767117-2	5767119-2	5767119-9
114	50.80 2.000	48.21 1.898	36.83 1.450	2	25.40 1.000	1.35 [.053] 2.72 [.107] 2.64 [.104]	Sn	Gold	1-5767007-0	1-5767111-0	5767111-3	5767116-3	5767118-3	1-5767118-0
									PdNi	5767056-3	—	—	—	—
									—	—	—	5767117-3	5767119-3	1-5767119-0
152	63.50 2.500	60.91 2.398	49.53 1.950	3	38.10 1.500	1.35 [.053] 2.72 [.107] 2.64 [.104]	Sn	Gold	1-5767007-1	1-5767111-1	5767111-4	5767116-4	5767118-4	1-5767118-1
									PdNi	5767056-4	—	—	—	—
									—	—	—	5767117-4	5767119-4	1-5767119-1
190	76.20 3.000	73.61 2.898	62.23 2.450	4	50.80 2.000	1.35 [.053] 2.72 [.107] 2.64 [.104]	Sn	Gold	1-5767007-2	1-5767111-2	5767111-5	5767116-5	5767118-5	1-5767118-2
									PdNi	5767056-5	—	—	—	—
									—	—	—	5767117-5	5767119-5	1-5767119-2
228	88.90 3.500	86.31 3.398	74.93 2.950	5	63.50 2.500	1.35 [.053] 2.72 [.107] 2.64 [.104]	Sn	Gold	1-5767007-3	—	—	5767116-6	—	—
									PdNi	5767056-6	—	—	—	—
									—	—	—	5767117-6	—	—
266	101.60 4.000	99.01 3.898	87.63 3.450	6	76.20 3.000	1.35 [.053] 2.72 [.107] 2.64 [.104]	Sn	Gold	1-5767007-4	—	—	5767116-7	—	—
									PdNi	5767056-7	—	—	—	—
									—	—	—	5767117-7	—	—

Note: Part Numbers are RoHS compliant.

0.635mm MICTOR Connectors

MICTOR Vertical Plugs (Continued)

**9.00 [.354]
Stacking Height***

Related Product Data

Material and Finish — page 43

Performance Characteristics — page 43

Mating Receptacles — pages 56-61

Technical Documents — page 113

* 9.00 [.354] stack height when mated to vertical receptacle;
18.00 [.709] stack height when mated to vertical receptacle (extended height).

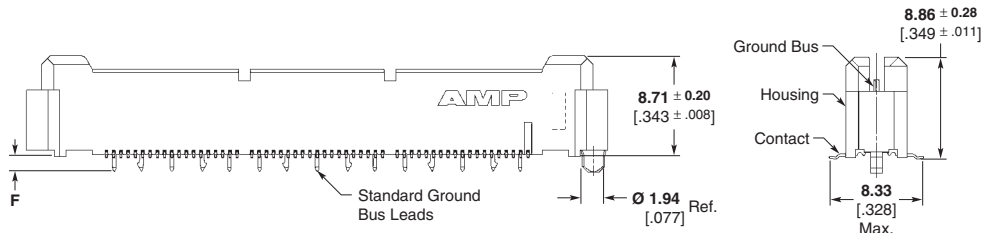
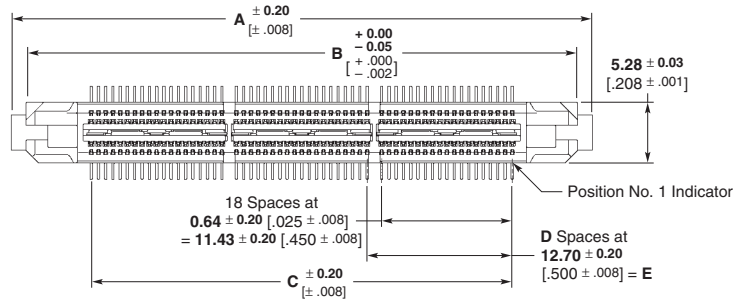

Note: For standard applications, the orientation hole must be 2.39±0.05 [.094±.002]; For slip-fit applications, the orientation hole must be 2.00±0.03 [.079±.001].

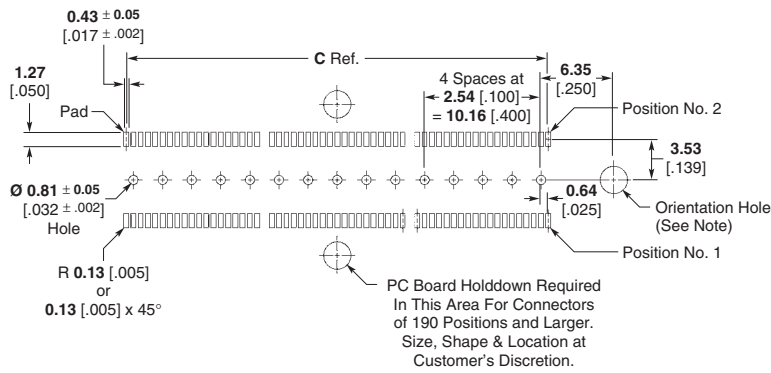

**Recommended PC Board Layout
(Viewed from Connector Side)**

No. of Pos.	Dimensions						Platings		Part Numbers	
	A	B	C	D	E	F	Solder Tail	Contact	Barbed G/B Leads	Tube
38	25.40	22.81	11.43	0	—	1.52 [.060]	Sn	Gold	5767139-1	
	1.000	.898	.450			2.74 [.108]		PdNi	5767140-1	
76	38.10	31.70	24.13	1	12.70	1.52 [.060]	Sn	Gold	5767139-2	
	1.500	1.248	.950			2.74 [.108]		PdNi	5767140-2	
114	50.80	48.21	36.83	2	25.40	1.52 [.060]	Sn	Gold	5767139-3	
	2.000	1.898	1.450			2.74 [.108]		PdNi	5767140-3	
152	63.50	60.91	49.53	3	38.10	1.52 [.060]	Sn	Gold	5767139-4	
	2.500	2.398	1.950			2.74 [.108]		PdNi	5767140-4	
190	76.20	73.61	62.23	4	50.80	1.52 [.060]	Sn	Gold	5767139-5	
	3.000	2.898	2.450			2.74 [.108]		PdNi	5767140-5	
228	88.90	86.31	74.93	5	63.50	1.52 [.060]	Sn	Gold	5767139-6	
	3.500	3.398	2.950			2.74 [.108]		PdNi	5767140-6	
266	101.60	99.01	87.63	6	76.20	1.52 [.060]	Sn	Gold	5767139-7	
	4.000	3.898	3.450			2.74 [.108]		PdNi	5767140-7	

Note: Part Numbers are RoHS compliant.

MICTOR Vertical Plugs (Continued)

**11.00 [.430]
Stacking Height***

Related Product Data

- Material and Finish** — page 43
- Performance Characteristics** — page 43
- Mating Receptacles** — pages 56-61
- Technical Documents** — page 113

* 11.00 [.430] stack height when mated to vertical receptacle; 19.94 [.785] stack height when mated to vertical receptacle (extended height).

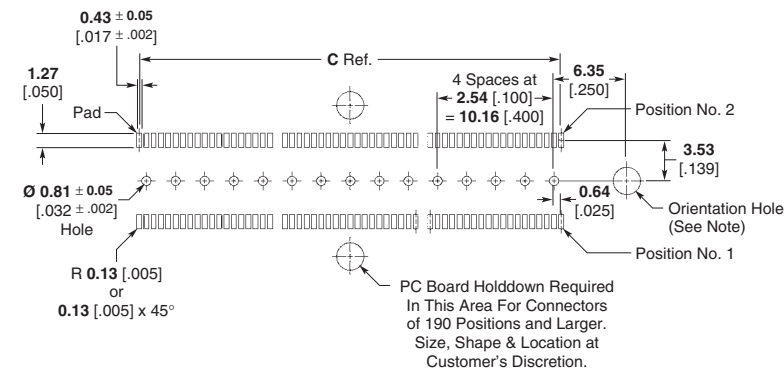
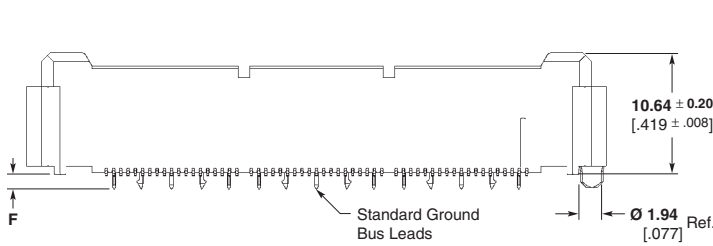
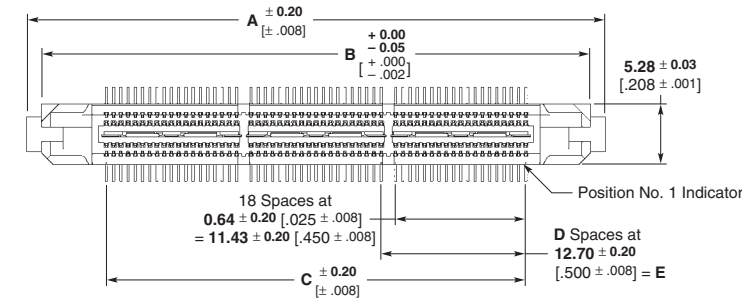

Note: For standard applications, the orientation hole must be 2.39±0.05 [.094±.002]; For slip-fit applications, the orientation hole must be 2.00±0.03 [.079±.001].

**Recommended PC Board Layout
(Viewed from Connector Side)**

No. of Pos.	Dimensions						Platings		Part Numbers				
	A	B	C	D	E	F	Solder Tail	Contact	Barbed G/B Leads		Barbless G/B Leads		
									Tube	T&R Vacuum Caps		Tube	T&R Vacuum Caps
	With	Without	With	Without									
38	25.40	22.81	11.43	0	—	1.52 [.060]	Sn	Gold	5767003-9	5767123-8	5767123-1	—	—
	1.000	.898	.450						2.64 [.104]	PdNi	5767087-1	—	—
76	38.10	31.70	24.13	1	12.70	1.52 [.060]	Sn	Gold	1-5767003-0	5767123-9	5767123-2	—	—
	1.500	1.248	.950						2.64 [.104]	PdNi	5767087-2	—	—
114	50.80	48.21	36.83	2	25.40	1.52 [.060]	Sn	Gold	1-5767003-1	1-5767123-0	5767123-3	1-5767182-3	1-5767183-0
	2.000	1.898	1.450						2.64 [.104]	PdNi	5767087-3	—	—
152	63.50	60.91	49.53	3	38.10	1.52 [.060]	Sn	Gold	5767003-8	—	—	—	—
	2.500	2.398	1.950						2.64 [.104]	PdNi	5767087-4	—	—
190	76.20	73.61	62.23	4	50.80	1.52 [.060]	Sn	Gold	1-5767003-2	1-5767123-2	5767123-5	—	—
	3.000	2.898	2.450						2.64 [.104]	PdNi	5767087-5	—	—
228	88.90	86.31	74.93	5	63.50	1.52 [.060]	Sn	Gold	1-5767003-3	—	—	—	—
	3.500	3.398	2.950						2.64 [.104]	PdNi	5767087-6	—	—
266	101.60	99.01	87.63	6	76.20	1.52 [.060]	Sn	Gold	1-5767003-4	—	—	—	—
	4.000	3.898	3.450						2.64 [.104]	PdNi	5767087-7	—	—

Note: Part Numbers are RoHS compliant.

MICTOR Vertical Plugs (Continued)

**12.57 [.495]
Stacking Height***

Related Product Data

Material and Finish — page 43

Performance Characteristics — page 43

Mating Receptacles — pages 56-61

Technical Documents — page 113

* 12.57 [.495] stack height when mated to vertical receptacle; 21.59 [.850] stack height when mated to vertical receptacle (extended height).

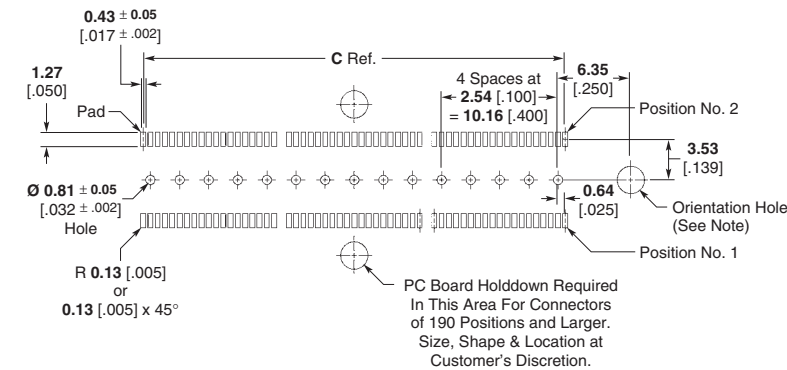
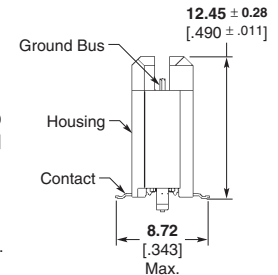
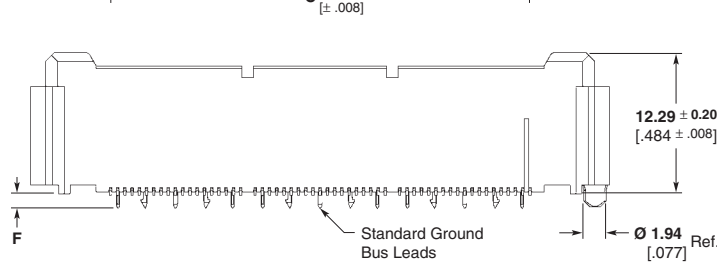
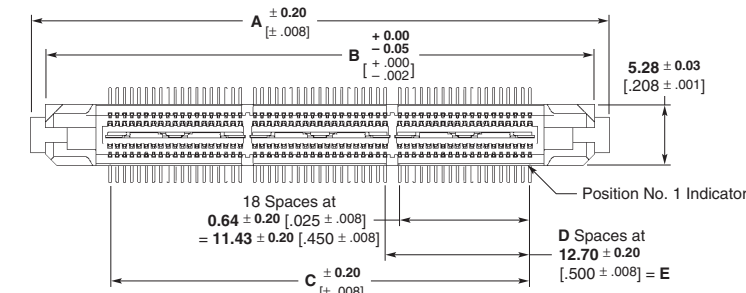

Note: For standard applications, the orientation hole must be 2.39±0.05 [.094±.002]; For slip-fit applications, the orientation hole must be 2.00±0.03 [.079±.001].

**Recommended PC Board Layout
(Viewed from Connector Side)**

No. of Pos.	Dimensions						Platings		Part Numbers					
	A	B	C	D	E	F	Solder Tail	Contact	Barbed G/B Leads			Barbless G/B Leads		
									Tube	T&R Vacuum Caps		Tube	T&R Vacuum Caps	
							With			Without			With	
38	25.40	22.81	11.43	0	—	1.52 [.060]	Sn	Gold	5767005-8	5767149-1	5767149-8	5767120-1	5767121-1	5767121-8
	1.000	.898	.450			2.64 [.104]			PdNi	5767057-1	—	—	5767082-1	—
76	38.10	31.70	24.13	1	12.70	1.52 [.060]	Sn	Gold	5767005-9	5767149-2	5767149-9	5767120-2	5767121-2	5767121-9
	1.500	1.248	.950		.500	2.64 [.104]			PdNi	5767057-2	—	—	5767082-2	—
114	50.80	48.21	36.83	2	25.40	1.52 [.060]	Sn	Gold	1-5767005-0	5767149-3	1-5767149-0	5767120-3	5767121-3	1-5767121-0
	2.000	1.898	1.450		1.000	2.64 [.104]			PdNi	5767057-3	—	—	5767082-3	—
152	63.50	60.91	49.53	3	38.10	1.52 [.060]	Sn	Gold	1-5767005-1	5767149-4	1-5767149-1	5767120-4	5767121-4	1-5767121-1
	2.500	2.398	1.950		1.500	2.64 [.104]			PdNi	5767057-4	—	—	5767082-4	5767127-4
190	76.20	73.61	62.23	4	50.80	1.52 [.060]	Sn	Gold	1-5767005-2	5767149-5	1-5767149-2	5767120-5	—	—
	3.000	2.898	2.450		2.000	2.64 [.104]			PdNi	5767057-5	—	—	5767082-5	5767127-5
228	88.90	86.31	74.93	5	63.50	1.52 [.060]	Sn	Gold	1-5767005-3	—	—	5767120-6	—	—
	3.500	3.398	2.950		2.500	2.64 [.104]			PdNi	5767057-6	—	—	5767082-6	—
266	101.60	99.01	87.63	6	76.20	1.52 [.060]	Sn	Gold	1-5767005-4	—	—	5767120-7	—	—
	4.000	3.898	3.450		3.000	2.64 [.104]			PdNi	5767057-7	—	1-5767151-4	5767082-7	—

Note: Part Numbers are RoHS compliant.

MICTOR Vertical Plugs (Continued)

**17.96 [.707]
Stacking Height***

Related Product Data

Material and Finish — page 43

Performance Characteristics — page 43

Mating Receptacles — pages 56-61

Technical Documents — page 113

* 17.96 [.707] stack height when mated to vertical receptacle; 26.97 [1.062] stack height when mated to vertical receptacle (extended height).

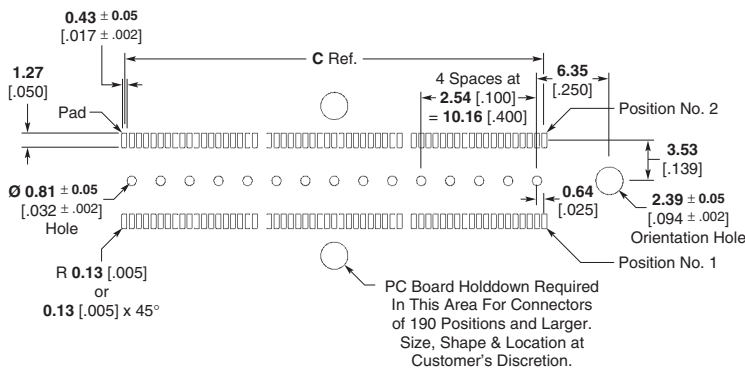
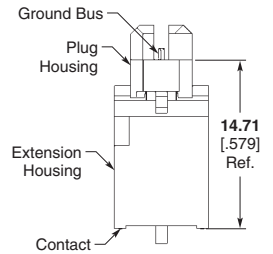
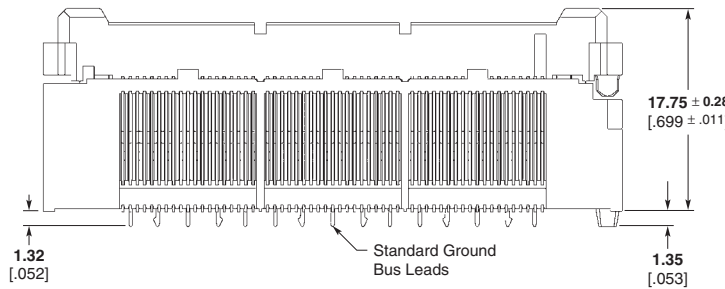
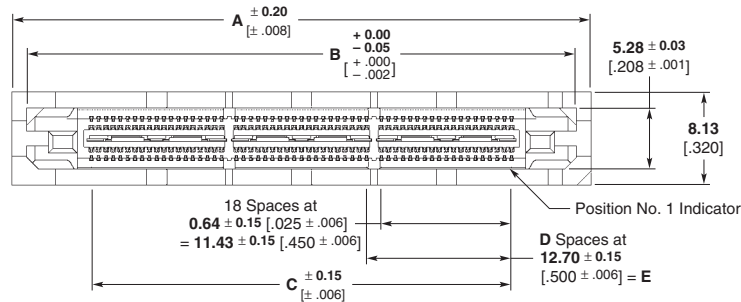

- Notes:**
1. For dual application, the orientation hole must be 1.98±0.03 [.078±.001]. See Application Specification 114-11004 for details.
 2. Connectors with extended ground bus leads can be made available, consult Tyco Electronics.

**Recommended PC Board Layout
(Connector Side of Board Shown)**

No. of Pos.	Dimensions					Part Numbers
	A	B	C	D	E	
38	25.40 1.000	22.81 .898	11.43 .450	0	0.00 .000	5767025-1
76	38.10 1.500	35.51 1.398	24.13 .950	1	12.70 .500	5767025-2
114	50.80 2.000	48.21 1.898	36.83 1.450	2	25.40 1.000	5767025-3
152	63.50 2.500	60.91 2.398	49.53 1.950	3	38.10 1.500	5767025-4
190	76.20 3.000	73.61 2.898	62.23 2.450	4	50.80 2.000	5767025-5
228	88.90 3.500	86.31 3.398	74.93 2.950	5	63.50 2.500	5767025-6
266	101.60 4.000	99.00 3.898	87.63 3.450	6	76.20 3.000	5767025-7

Note: Part Numbers are RoHS compliant.

0.635mm MICTOR Connectors

MICTOR Vertical Plugs (Continued)

**18.75 [.738]
Stacking Height***

Related Product Data

Material and Finish — page 43

Performance Characteristics — page 43

Mating Receptacles — pages 56-61

Technical Documents — page 113

* 18.75 [.738] stack height when mated to vertical receptacle;
27.76 [1.093] stack height when mated to vertical receptacle (extended height).

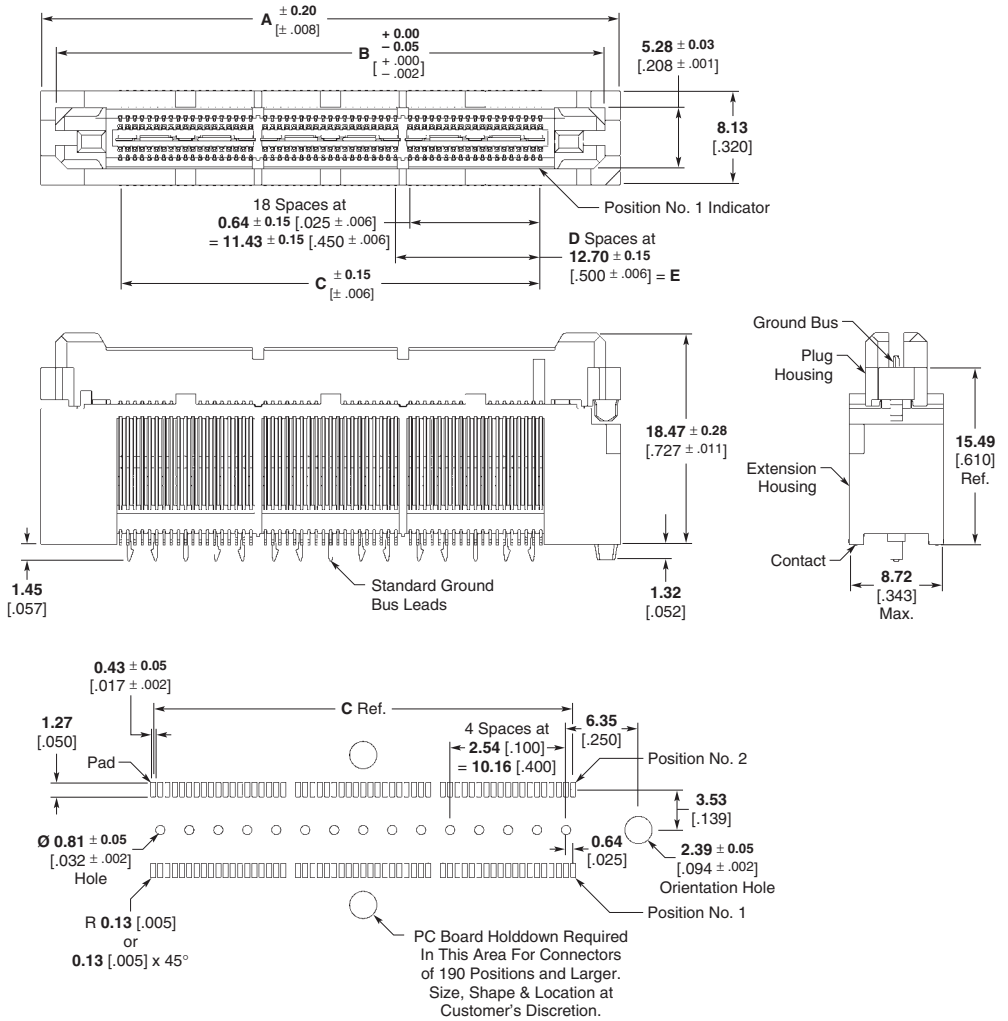

**Recommended PC Board Layout
(Connector Side of Board Shown)**

No. of Pos.	Dimensions					Part Numbers
	A	B	C	D	E	
38	25.40 1.000	22.81 .898	11.43 .450	0	0.00 .000	5767042-1
76	38.10 1.500	35.51 1.398	24.13 .950	1	12.70 .500	5767042-2
114	50.80 2.000	48.21 1.898	36.83 1.450	2	25.40 1.000	5767042-3
152	63.50 2.500	60.91 2.398	49.53 1.950	3	38.10 1.500	5767042-4
190	76.20 3.000	73.61 2.898	62.23 2.450	4	50.80 2.000	5767042-5
228	88.90 3.500	86.31 3.398	74.93 2.950	5	63.50 2.500	5767042-6
266	101.60 4.000	99.00 3.898	87.63 3.450	6	76.20 3.000	5767042-7

Note: Part Numbers are RoHS compliant.

MICTOR Vertical Plugs (Continued)

**20.00 [.785]
Stacking Height***

Related Product Data

Material and Finish — page 43

Performance Characteristics — page 43

Mating Receptacles — pages 56-61

Technical Documents — page 113

* 20.02 [.788] stack height when mated to vertical receptacle;
29.03 [1.143] stack height when mated to vertical receptacle (extended height).

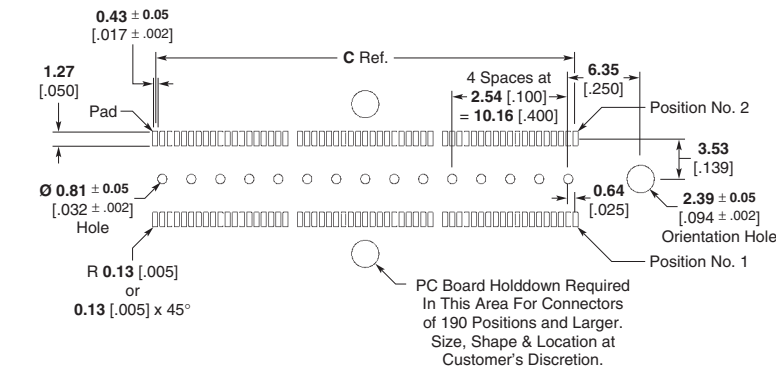
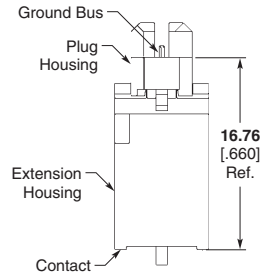
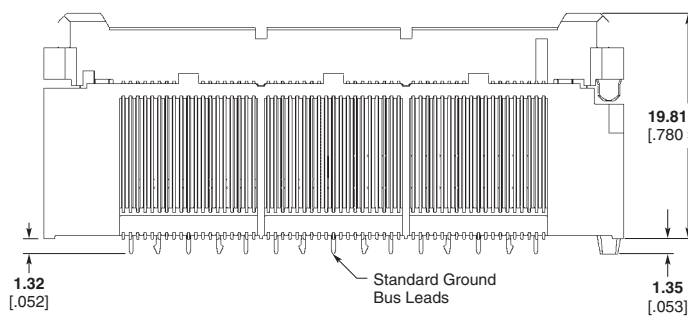
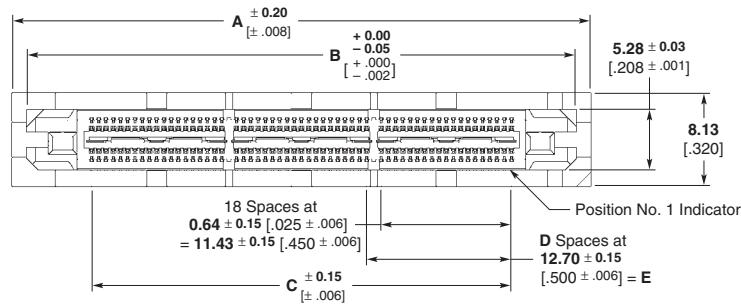

- Notes:**
1. For dual application, the orientation hole must be 1.98±0.03 [.078±.001]. See Application Specification 114-11004 for details.
 2. Connectors with extended ground bus leads can be made available, consult Tyco Electronics.

**Recommended PC Board Layout
(Connector Side of Board Shown)**

No. of Pos.	Dimensions					Part Numbers
	A	B	C	D	E	
38	25.40 1.000	22.81 .898	11.43 .450	0	0.00 .000	5767032-1
76	38.10 1.500	35.51 1.398	24.13 .950	1	12.70 .500	5767032-2
114	50.80 2.000	48.21 1.898	36.83 1.450	2	25.40 1.000	5767032-3
152	63.50 2.500	60.91 2.398	49.53 1.950	3	38.10 1.500	5767032-4
190	76.20 3.000	73.61 2.898	62.23 2.450	4	50.80 2.000	5767032-5
228	88.90 3.500	86.31 3.398	74.93 2.950	5	63.50 2.500	5767032-6
266	101.60 4.000	99.00 3.898	87.63 3.450	6	76.20 3.000	5767032-7

Note: Part Numbers are RoHS compliant.

MICTOR Vertical Plugs (Continued)

**22.86 [.900]
Stacking Height***

Related Product Data

Material and Finish — page 43

Performance Characteristics — page 43

Mating Receptacles — pages 56-61

Technical Documents — page 113

* 22.86 [.900] stack height when mated to vertical receptacle;
31.89 [1.255] stack height when mated to vertical receptacle (extended height).

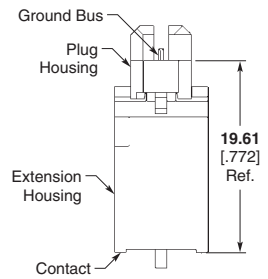
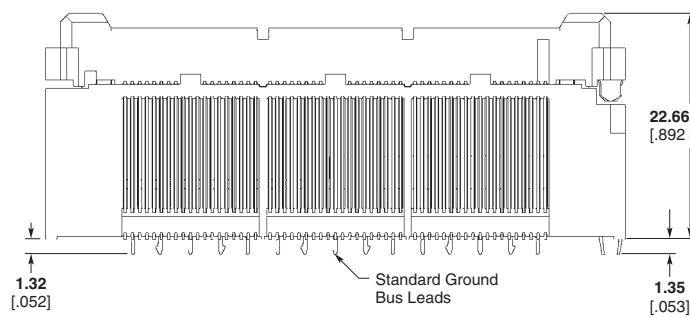
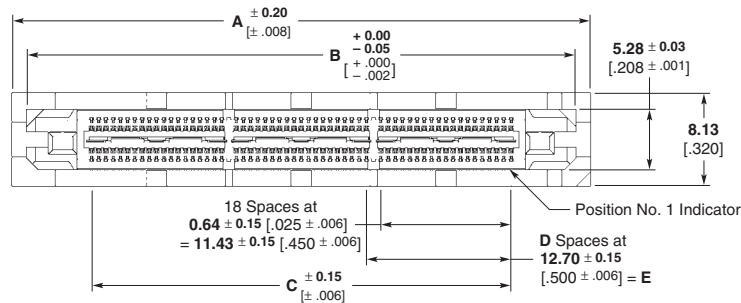

- Notes:**
1. For dual application, the orientation hole must be 1.98 ± 0.03 [$.078 \pm .001$]. See Application Specification 114-11004 for details.
 2. Connectors with extended ground bus leads can be made available, consult Tyco Electronics.

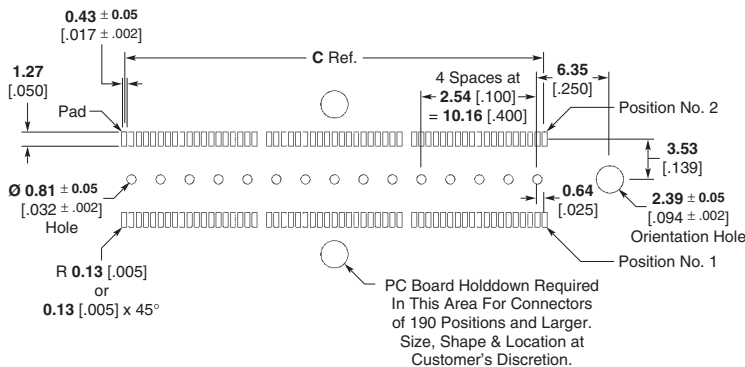

**Recommended PC Board Layout
(Connector Side of Board Shown)**

No. of Pos.	Dimensions					Part Numbers
	A	B	C	D	E	
38	25.40 1.000	22.81 .898	11.43 .450	0	0.00 .000	5767017-1
76	38.10 1.500	35.51 1.398	24.13 .950	1	12.70 .500	5767017-2
114	50.80 2.000	48.21 1.898	36.83 1.450	2	25.40 1.000	5767017-3
152	63.50 2.500	60.91 2.398	49.53 1.950	3	38.10 1.500	5767017-4
190	76.20 3.000	73.61 2.898	62.23 2.450	4	50.80 2.000	5767017-5
228	88.90 3.500	86.31 3.398	74.93 2.950	5	63.50 2.500	5767017-6
266	101.60 4.000	99.00 3.898	87.63 3.450	6	76.20 3.000	5767017-7

Note: Part Numbers are RoHS compliant.

MICTOR Right Angle Plugs

Related Product Data

- Material and Finish** — page 43
- Performance Characteristics** — page 43
- Mating Receptacles** — pages 56-61
- Technical Documents** — page 113

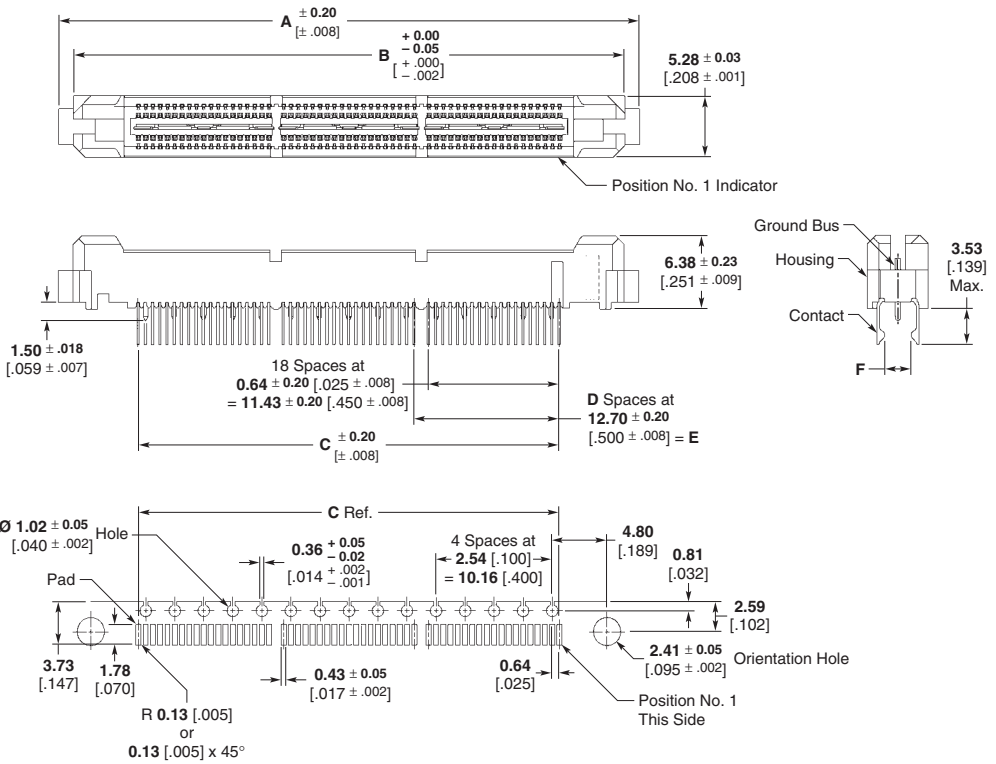

**Recommended PC Board Layout
(Mirror Image on Opposite Side)**

0.635mm MICTOR Connectors

MICTOR Right Angle Plugs (Continued)

No. of Pos.	Dimensions						Platings		Part Numbers
	A	B	C	D	E	F	Solder Tail	Contact	Tube
38	25.40 1.000	22.81 .898	11.43 .450	0	0.00 .000	1.52 .060	Sn	Gold	5767006-1
						1.52 .060	Sn	PdNi	5767055-1
						2.31 .091	Sn	PdNi	5767039-1
76	38.10 1.500	35.51 1.398	24.13 .950	1	12.70 .500	1.52 .060	Sn	Gold	5767006-2
						1.52 .060	Sn	PdNi	5767055-2
						2.31 .091	Sn	PdNi	5767039-2
						2.97 .117	Sn	PdNi	5767170-2
114	50.80 2.000	48.21 1.898	36.83 1.450	2	25.40 1.000	1.52 .060	Sn	Gold	5767006-3
						1.52 .060	Sn	PdNi	5767055-3
						2.31 .091	Sn	PdNi	5767039-3
152	63.50 2.500	60.91 2.398	49.53 1.950	3	38.10 1.500	1.52 .060	Sn	Gold	5767006-4
						1.52 .060	Sn	PdNi	5767055-4
						2.31 .091	Sn	PdNi	5767039-4
190	76.20 3.000	73.61 2.898	62.23 2.450	4	50.80 2.000	1.52 .060	Sn	Gold	5767006-5
						1.52 .060	Sn	PdNi	5767055-5
						2.31 .091	Sn	PdNi	5767039-5
228	88.90 3.500	86.31 3.398	74.93 2.950	5	63.50 2.500	1.52 .060	Sn	Gold	5767006-6
						1.52 .060	Sn	PdNi	5767055-6
						2.31 .091	Sn	PdNi	5767039-6
266	101.60 4.000	99.00 3.898	87.63 3.450	6	76.20 3.000	1.52 .060	Sn	Gold	5767006-7
						1.52 .060	Sn	PdNi	5767055-7
						2.31 .091	Sn	PdNi	5767039-7

Note: Part Numbers are RoHS compliant.

0.635mm MICTOR Connectors

MICTOR Vertical Receptacles

Related Product Data

- Material and Finish** — page 43
- Performance Characteristics** — page 43
- Mating Plugs** — pages 46-55
- Technical Documents** — page 113

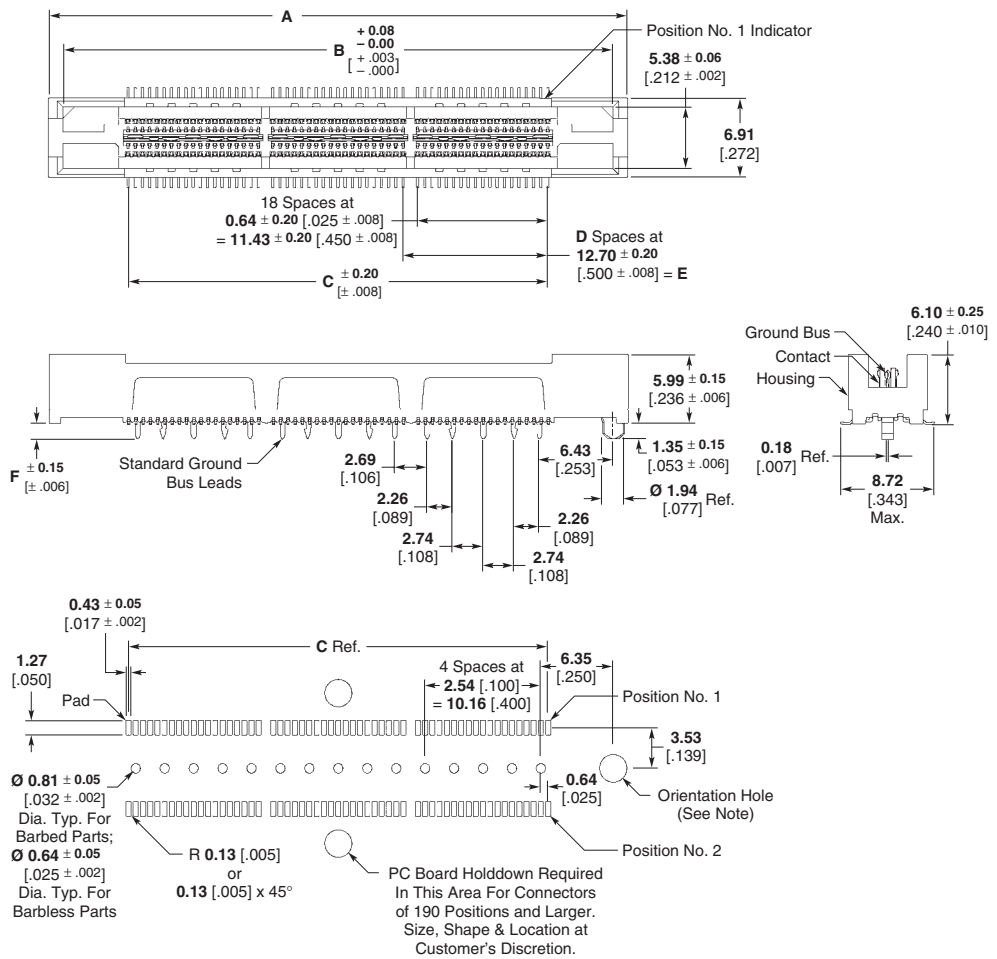

**Recommended PC Board Layout
(Connector Side of Board Shown)**

Note: For standard applications, orientation hole to be Ø 2.39±0.05 [.094±.002]; For slip-fit applications, orientation hole to be Ø 2.00±0.03 [.079±.001].

0.635mm MICTOR Connectors

MICTOR Vertical Receptacles (Continued)

No. of Pos.	Dimensions						Platings		Part Numbers					
	A	B	C	D	E	F	Solder Tail	Contact	Barbed G/B Leads			Barbless G/B Leads		
									Tube	T&R Vacuum Caps		Tube	T&R Vacuum Caps	
										With	Without		With	Without
38	25.40 1.000	22.86 .900	11.43 .450	0	—	1.40 .055	Sn	Gold	2-5767004-2	5767096-8	5767096-1	5767110-1	5767114-1	5767114-8
						2.74 .108	Sn	Gold	5767181-1	—	—	—	—	—
								PdNi	5767054-1	5767171-1	—	5767081-1	5767115-1	—
76	38.10 1.500	35.56 1.400	24.13 .950	1	12.70 .500	1.40 .055	Sn	Gold	2-5767004-3	5767096-9	5767096-2	5767110-2	5767114-2	5767114-9
						2.74 .108	Sn	Gold	5767181-2	—	—	—	—	—
								PdNi	5767054-2	—	—	5767081-2	5767115-2	—
114	50.80 2.000	48.26 1.900	36.83 1.450	2	25.40 1.000	1.40 .055	Sn	Gold	2-5767004-4	1-5767096-0	5767096-3	5767110-3	5767114-3	1-5767114-0
						2.74 .108	Sn	Gold	5767181-3	—	—	—	—	—
								PdNi	5767054-3	—	—	5767081-3	5767115-3	—
152	63.50 2.500	60.96 2.400	49.53 1.950	3	38.10 1.500	1.40 .055	Sn	Gold	2-5767004-5	1-5767096-1	5767096-4	5767110-4	5767114-4	1-5767114-1
						2.74 .108	Sn	Gold	5767181-4	—	—	—	—	—
								PdNi	5767054-4	—	—	5767081-4	5767115-4	—
190	76.20 3.000	73.66 2.900	62.23 2.450	4	50.80 2.000	1.40 .055	Sn	Gold	2-5767004-6	1-5767096-2	5767096-5	5767110-5	5767114-5	1-5767114-2
						2.74 .108	Sn	Gold	5767181-5	—	—	—	—	—
								PdNi	5767054-5	—	—	5767081-5	5767115-5	—
228	88.90 3.500	86.36 3.400	74.93 2.950	5	63.50 2.500	1.40 .055	Sn	Gold	2-5767004-7	—	—	5767110-6	—	—
						2.74 .108	Sn	Gold	5767181-6	—	—	—	—	—
								PdNi	5767054-6	—	—	5767081-6	—	—
266	101.60 4.000	99.06 3.900	87.63 3.450	6	76.20 3.000	1.40 .055	Sn	Gold	2-5767004-8	—	—	5767110-7	—	—
						2.74 .108	Sn	Gold	5767181-7	—	—	—	—	—
								PdNi	5767054-7	—	—	5767081-7	—	—

Note: Part Numbers are RoHS compliant.

0.635mm MICTOR Connectors

MICTOR Vertical Receptacles (Extended Height)

Related Product Data

- Material and Finish** — page 43
- Performance Characteristics** — page 43
- Mating Plugs** — pages 46-55
- Technical Documents** — page 113

When mated with a standard vertical plug, this extended height receptacle adds 9.017 [.355] to the mated stack height when compared with the standard height vertical receptacle.

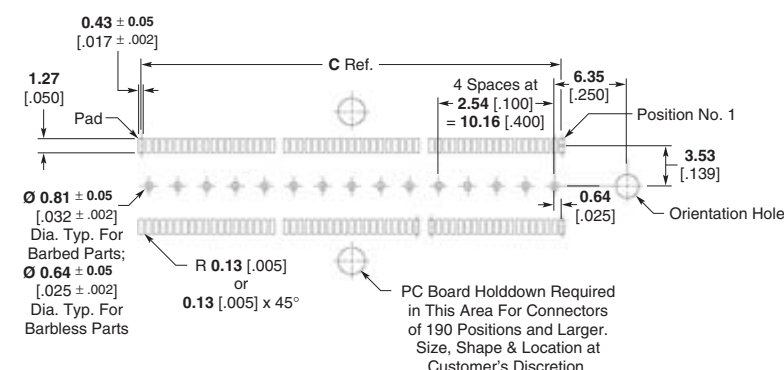
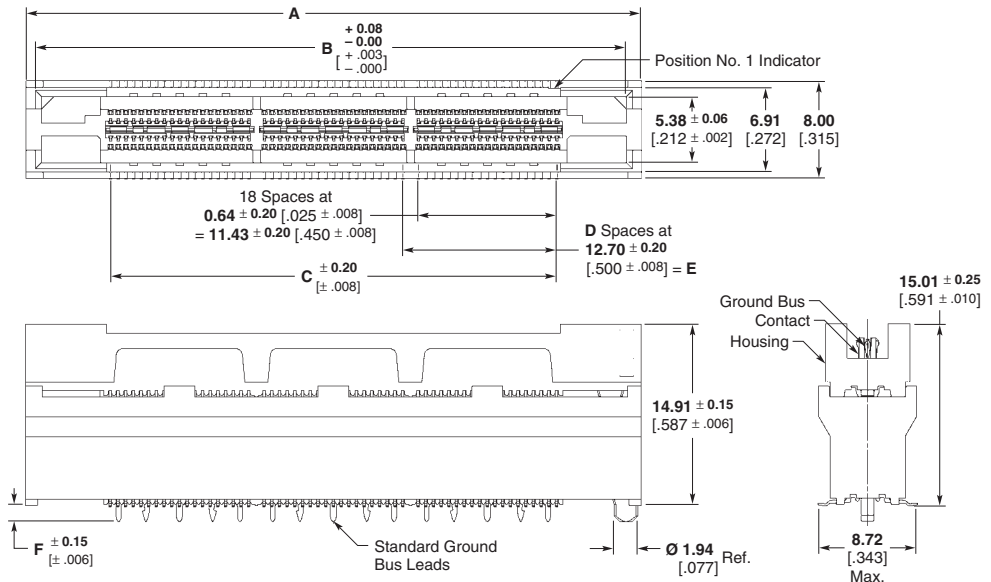

0.635mm MICTOR Connectors

MICTOR Vertical Receptacles (Extended Height) (Continued)

No. of Pos.	Dimensions						Platings		Part Numbers						
	A	B	C	D	E	F	Solder Tail	Contact	Barbed G/B Leads			Barbless G/B Leads			
									Tube	T&R Vacuum Caps		Tube	T&R Vacuum Caps		
										With	Without		With	Without	
38	25.40 1.000	22.86 .900	11.43 .450	0	—	1.37 [.054]	Sn	Gold	5767130-1	5767146-1	5767146-8	—	—	—	
						1.37 [.054]			PdNi	5767094-1	5767178-1	6761316-8	—	—	—
						2.72 [.107]			5767154-1	—	5767153-8	5767095-1	—	—	—
76	38.10 1.500	35.56 1.400	24.13 .950	1	12.70 .500	1.37 [.054]	Sn	Gold	5767130-2	5767146-2	5767146-9	—	—	—	
						1.37 [.054]			PdNi	5767094-2	5767178-2	—	—	—	
						2.72 [.107]			5767154-2	—	5767153-9	5767095-2	—	—	—
114	50.80 2.000	48.26 1.900	36.83 1.450	2	25.40 1.000	1.37 [.054]	Sn	Gold	5767130-3	5767146-3	1-5767146-0	—	—	—	
						1.37 [.054]			PdNi	5767094-3	—	—	—	—	
						2.72 [.107]			5767154-3	—	1-5767153-0	5767095-3	5767145-3	1-5767145-0	
152	63.50 2.500	60.96 2.400	49.53 1.950	3	38.10 1.500	1.37 [.054]	Sn	Gold	5767130-4	5767146-4	1-5767146-1	—	—	—	
						1.37 [.054]			PdNi	5767094-4	—	—	—	—	
						2.72 [.107]			5767154-4	—	1-5767153-1	5767095-4	—	1-5767145-1	
190	76.20 3.000	73.66 2.900	62.23 2.450	4	50.80 2.000	1.37 [.054]	Sn	Gold	5767130-5	—	—	—	—	—	
						1.37 [.054]			PdNi	5767094-5	5767178-5	1-6761316-2	—	—	—
						2.72 [.107]			5767154-5	—	1-5767153-2	5767095-5	—	—	—
228	88.90 3.500	86.36 3.400	74.93 2.950	5	63.50 2.500	1.37 [.054]	Sn	Gold	5767130-6	—	—	—	—	—	
						1.37 [.054]			PdNi	5767094-6	—	—	—	—	
						2.72 [.107]			5767154-6	—	1-5767153-3	5767095-6	—	—	—
266	101.60 4.000	99.06 3.900	87.63 3.450	6	76.20 3.000	1.37 [.054]	Sn	Gold	5767130-7	—	—	—	—	—	
						1.37 [.054]			PdNi	5767094-7	—	—	—	—	
						2.72 [.107]			5767154-7	—	1-5767153-4	5767095-7	—	—	—

Note: Part Numbers are RoHS compliant.

0.635mm MICTOR Connectors

MICTOR Right Angle Receptacles

Related Product Data

- Material and Finish** — page 43
- Performance Characteristics** — page 43
- Mating Plugs** — pages 46-55
- Application Tooling** — page 62
- Technical Documents** — page 113

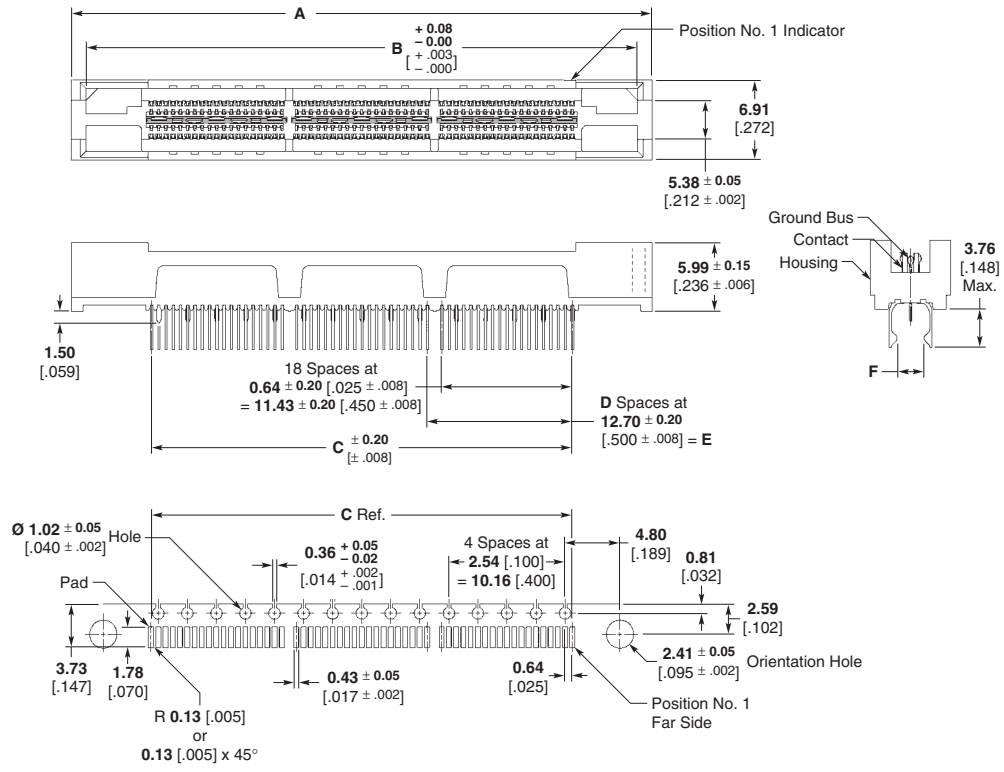

Recommended PC Board Layout
(Mirror image on opposite side)
PC Board Thickness: 1.57 / $[\pm .062]$

0.635mm MICTOR Connectors

MICTOR Right Angle Receptacles (Continued)

No. of Pos.	Dimensions						Platings		Part Numbers
	A	B	C	D	E	F	Solder Tail	Contact	Tube
38	25.40 1.000	22.86 .900	11.43 .450	0	0.00 .000	1.52 .060	Sn	Gold	5767143-1
						2.31 .091		PdNi	5767044-1
76	38.10 1.500	35.56 1.400	24.13 .950	1	12.70 .500	1.52 .060	Sn	Gold	5767143-2
						2.31 .091		PdNi	5767044-2
114	50.80 2.000	48.26 1.900	36.83 1.450	2	25.40 1.000	1.52 .060	Sn	Gold	5767143-3
						2.31 .091		PdNi	5767044-3
152	63.50 2.500	60.96 2.400	49.53 1.950	3	38.10 1.500	1.52 .060	Sn	Gold	5767143-4
						2.31 .091		PdNi	5767044-4
190	76.20 3.000	73.66 2.900	62.23 2.450	4	50.80 2.000	1.52 .060	Sn	Gold	5767143-5
						2.31 .091		PdNi	5767044-5
228	88.90 3.500	86.36 3.400	74.93 2.950	5	63.50 2.500	1.52 .060	Sn	Gold	5767143-6
						2.31 .091		PdNi	5767044-6
266	101.60 4.000	99.06 3.900	87.63 3.450	6	76.20 3.000	1.52 .060	Sn	Gold	5767143-7
						2.31 .091		PdNi	5767044-7

Note: Part Numbers are RoHS compliant.

0.635mm MICTOR Connectors

Application Tooling for MICTOR Right Angle Connectors

Two operations must be performed so that the MICTOR right angle connector can be successfully installed on a PC board. First, the board must be slit for the ground/bus bar. At the customer's option, this operation may be done at the time of board manufacture. Second, the right angle connector must be properly placed on the board.

Tyco Electronics offers bench-mount tooling for slitting the PC board (see below) and a free-standing tool for installing the connector (shown at the right). AMP Application Specification No. 114-11004 and Instruction Sheets are available to provide the necessary instructions and recommendations for proper tool use.

Application Specification No. 114-13008 for Right Angle.

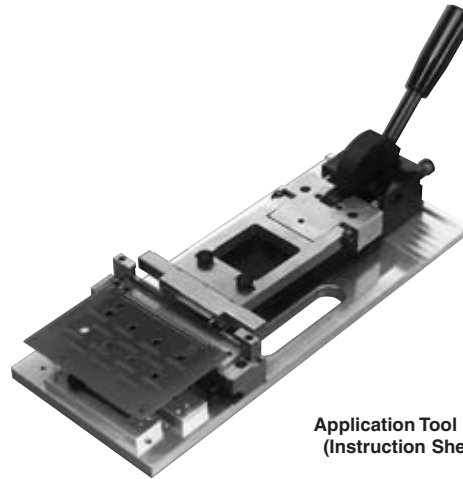

Application Tool Number 767511-1
(Instruction Sheet No. 408-4335)

Replacement Components for Tool Number 767511-1

Connector Size (No. of Positions)	Board Locator Pin		Plug Inserter	Receptacle Inserter	Support Pillar
	Round	Diamond			
38	767523-1	767526-1	767514-1	767570-1	767522-1
76	767523-1	767526-1	767514-2	767570-2	767522-1
114	767523-1	767526-1	767514-3	767570-3	767522-1
152	767523-1	767526-1	767514-4	767570-4	767522-1
190	767523-1	767526-1	767514-5	767570-5	767522-1
228	767523-1	767526-1	767514-6	767570-6	767522-1
266	767523-1	767526-1	767514-7	767570-7	767522-1



Slitting Tool Number 767527-1
(Instruction Sheet No. 408-4334)

Replacement Components for Tool Number 767527-1

Component Description	Quantity Required for Each Increment of 38 Positions (0.64 [.025] Centerline)	Part Number
Slitting Punch (Set of 35)	5	767532-1
Die Insert* (Set of 7)	1	767530-1

* The die insert is located in the tool with a 3.18 x 28.58 [.125 x 1.125] long dowel and held in place with a 6-32 UNC-2A x 7.94 [5/16] long socket head cap screw (not included with replacement insert).

Note: Part Numbers are RoHS compliant.